







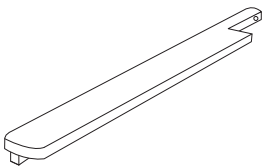
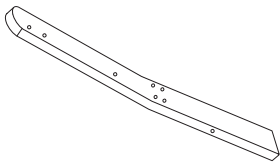
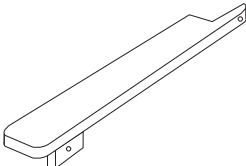

Komposit bænk

workmann

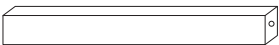

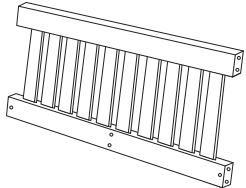
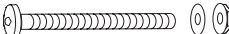
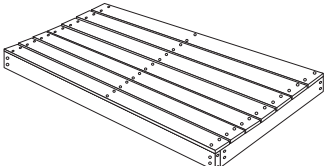
Manual

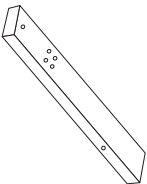
Læs venligst manualen inde du begynder, at tage bænken i brug!

 1. Vær sikker på, at du har modtaget alle dele til bænken

Nummer	Billede	Antal	Nummer	Billede	Antal
1		X1	7		X2
2		X1	A	 M6 X 50MM	X2
3		X2	B	 M6 X 70MM	X18
4		X1	C	 M6 X 70MM	X12
5		X1	D		X1
6		X2	E		X1

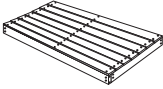
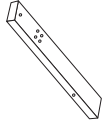
1

			
⑤ 1pc	⑥ 2pcs	ⓑ 4pcs	ⓒ 4pcs

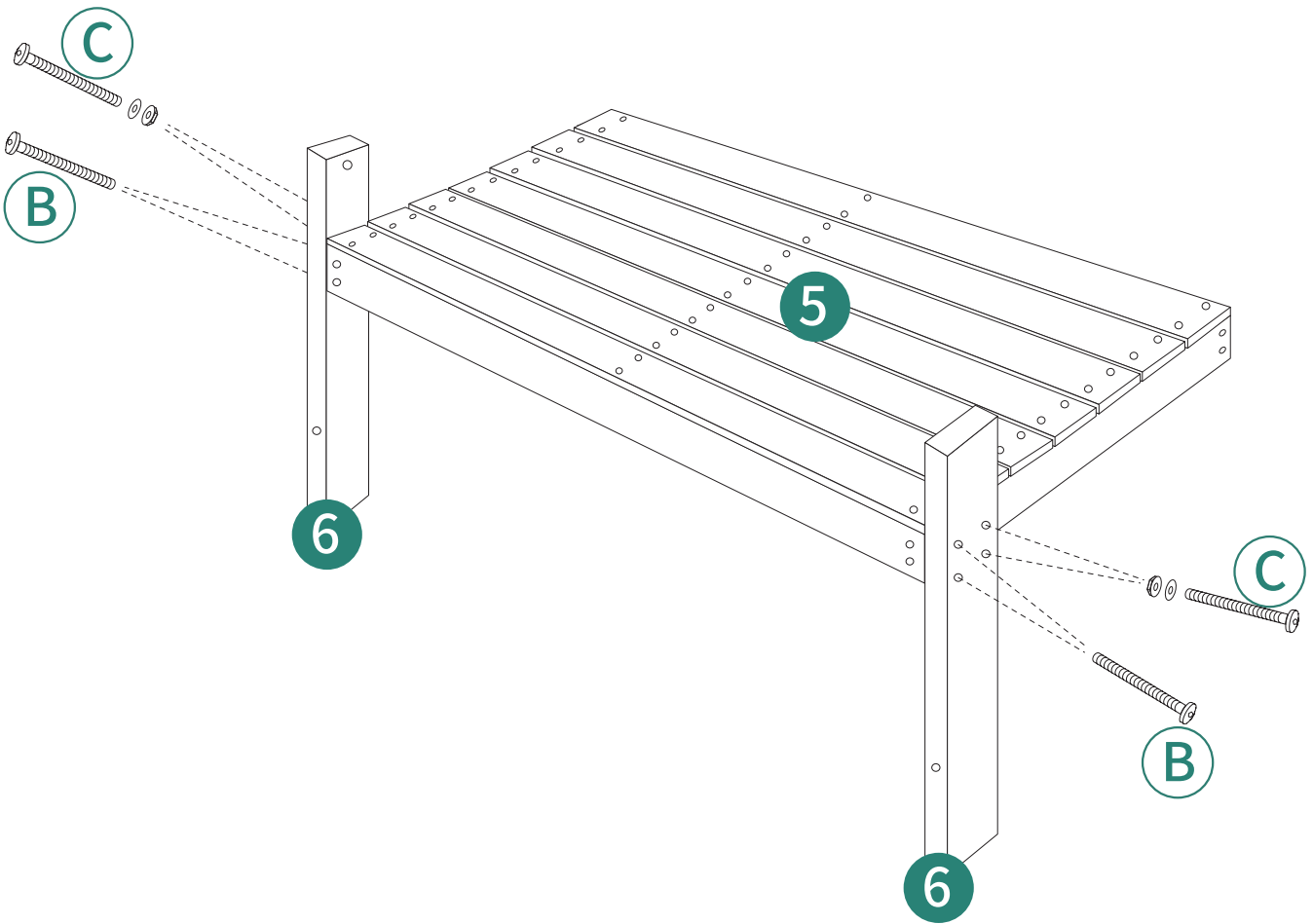

2

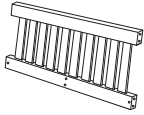

④ 1pc

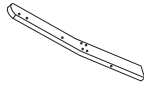

⑦ 2pcs



① A 2pcs

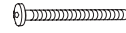

① B 10pcs



① C 4pcs

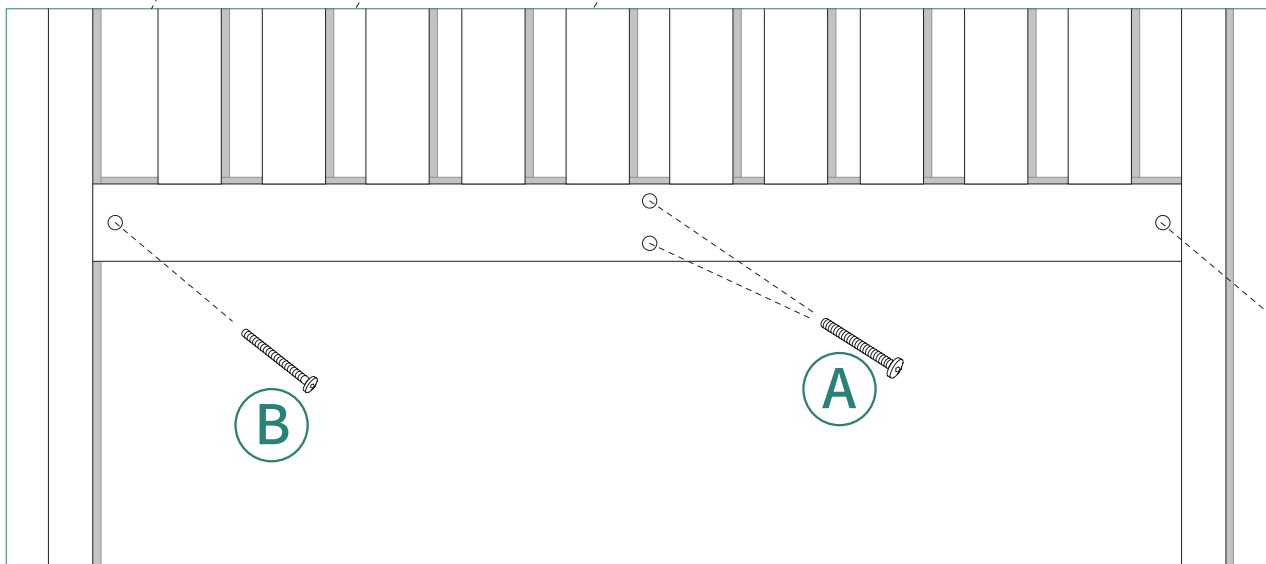
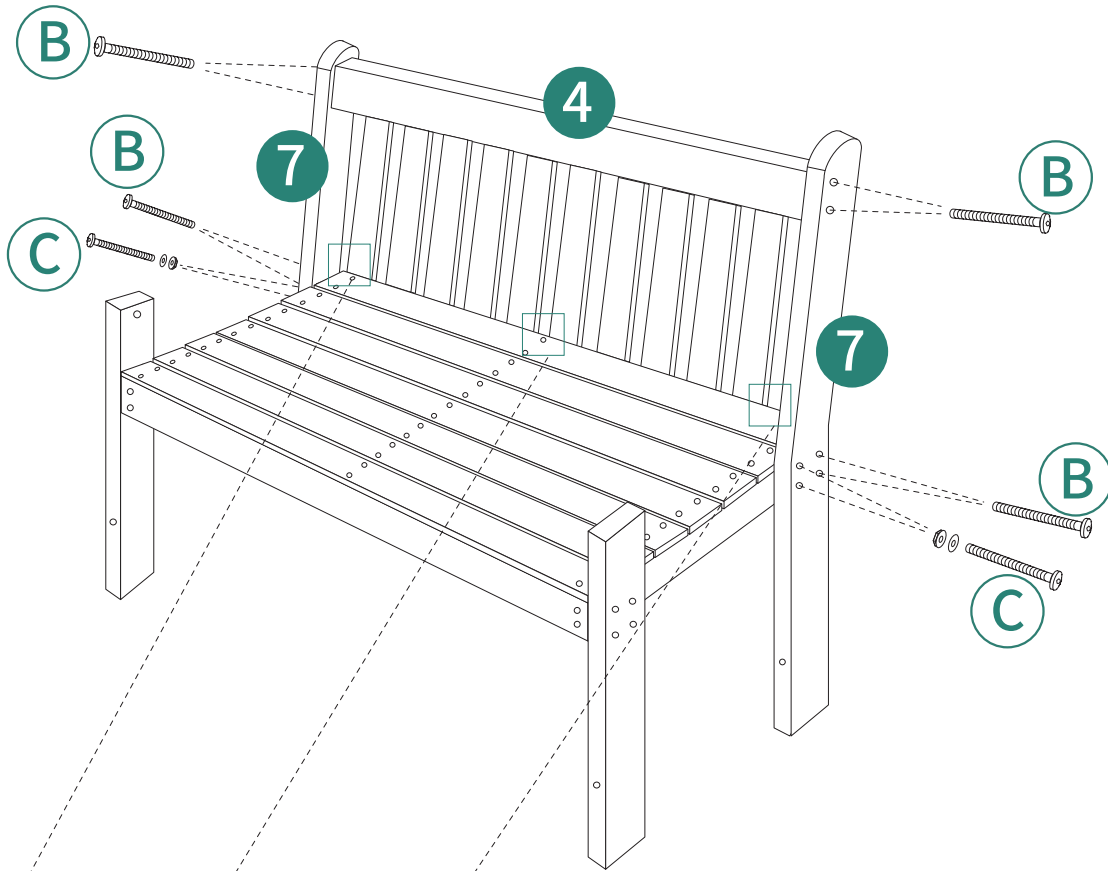

3

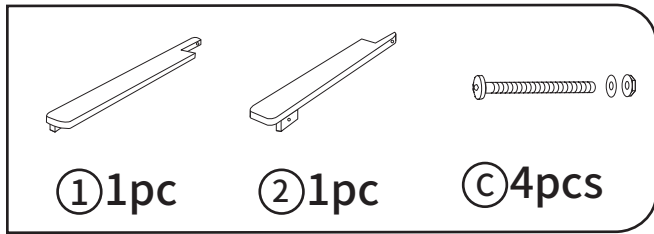

① 1pc ② 1pc ③ 4pcs

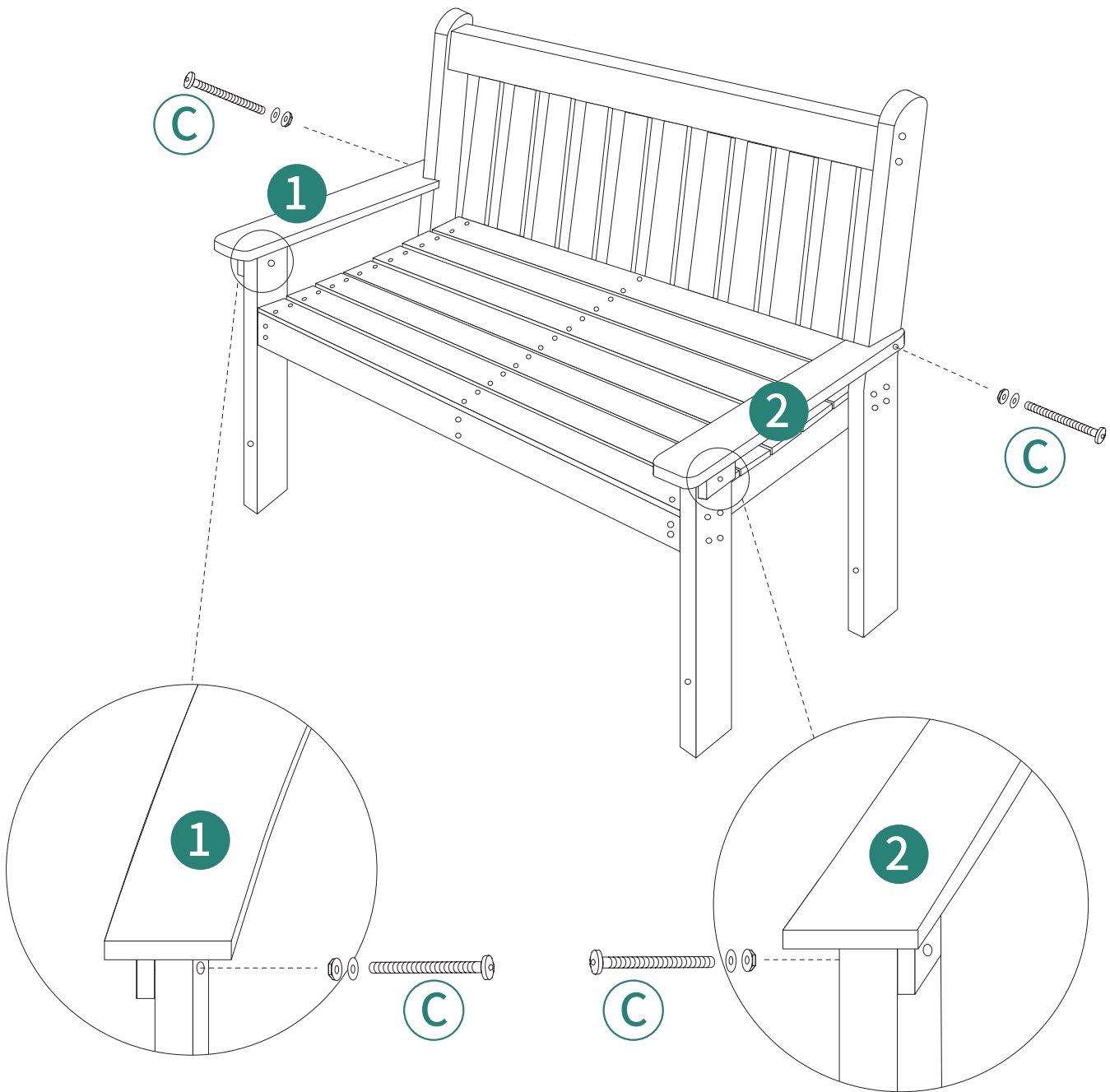

4

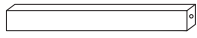

③ 2pcs

Ⓑ 4pcs

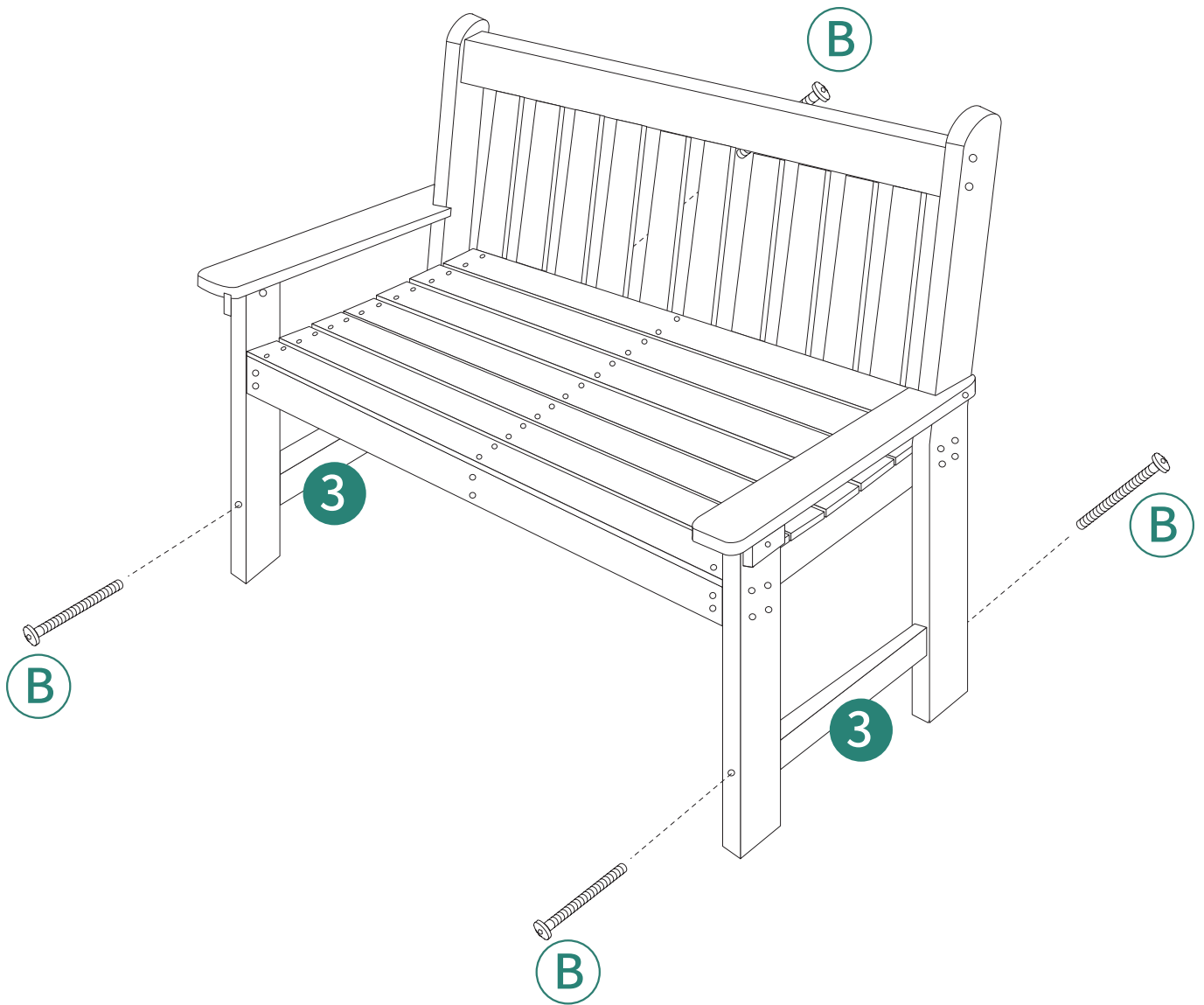

5



Nu er bænken klar til brug!