

140049

P1

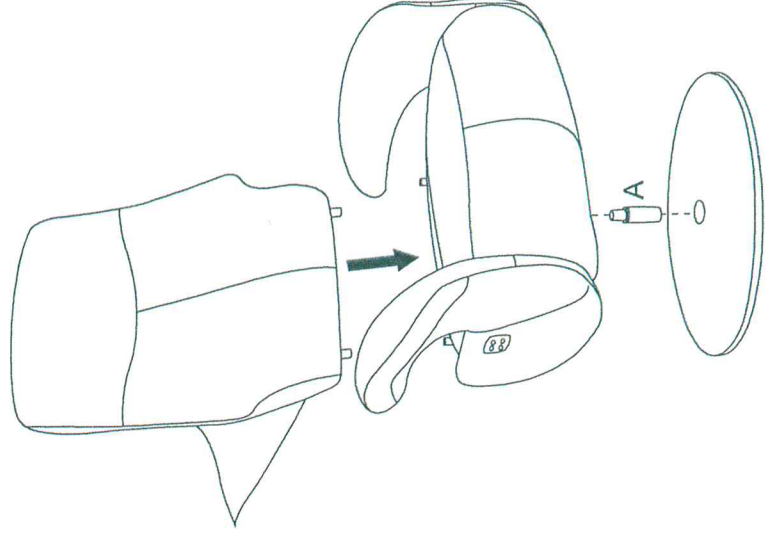

A

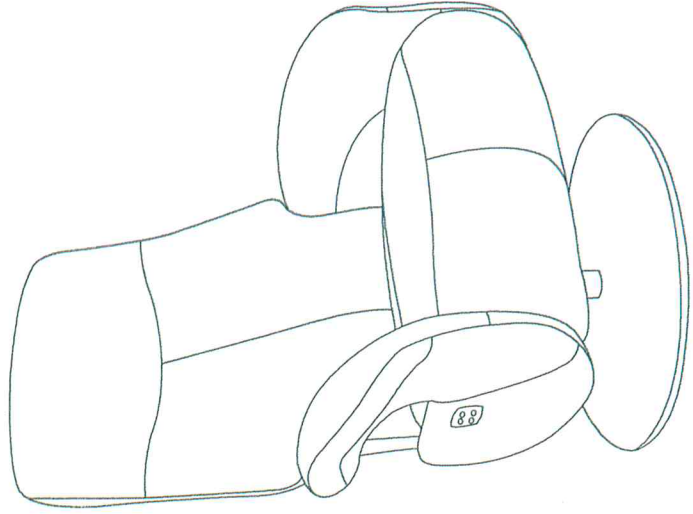
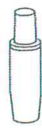

1PC

B



1PC

1

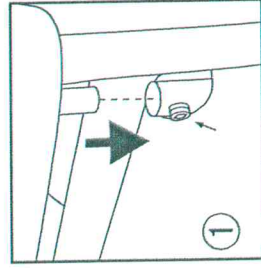

1

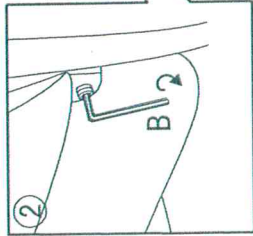
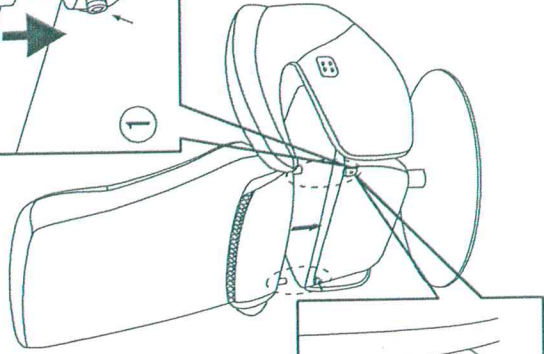

2

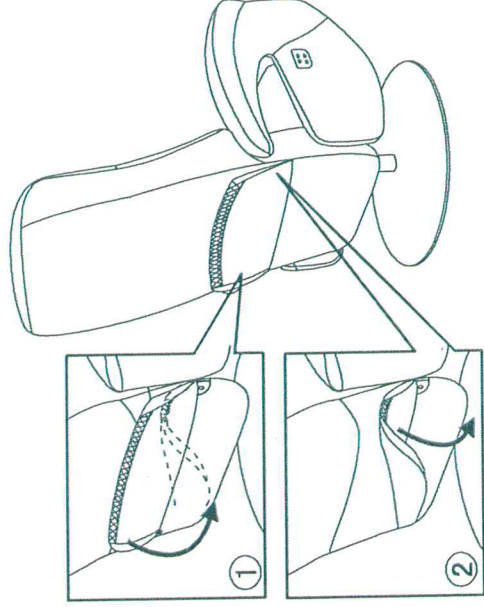

1

2

2

3

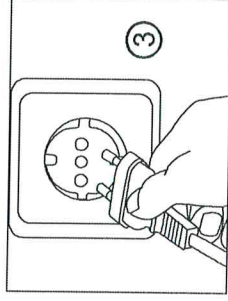
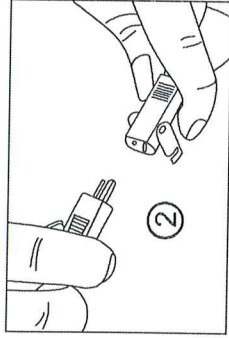
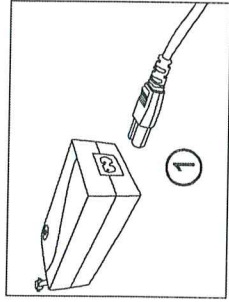

1

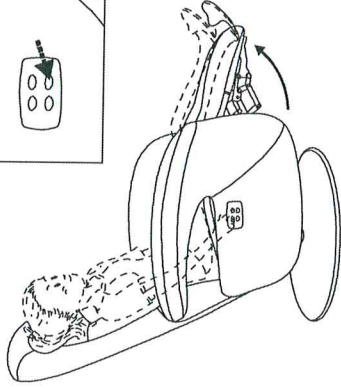
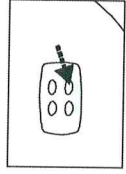

1. Press the button to raise the ottoman

2

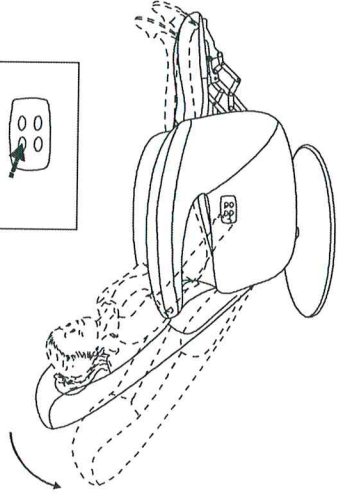
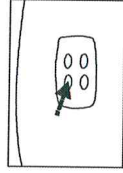

2. Press the button to recline

3

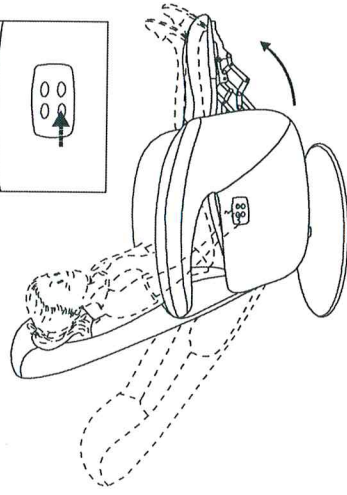
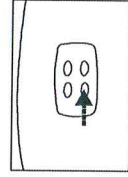

3. Press the button to return to upright position

4

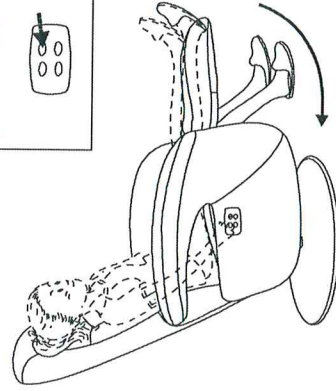
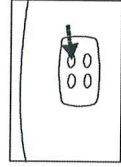

4. Press the button to stow the ottoman

HOW TO ADJUST HEADREST

P3

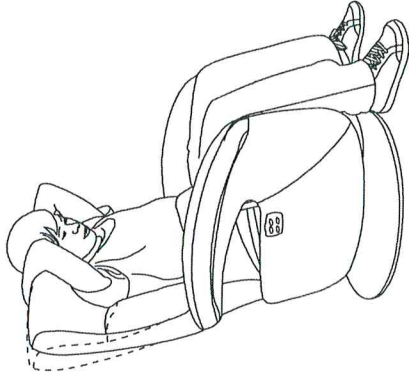

To adjust headrest: pull from back on both sides as shown.

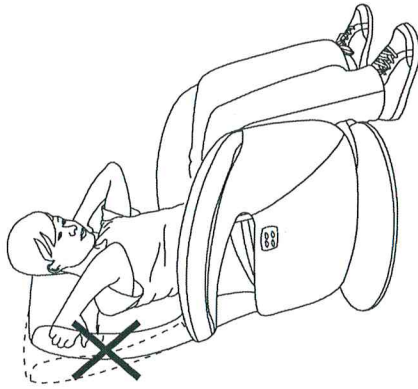

Do not pull from side edge to adjust, material may tear.

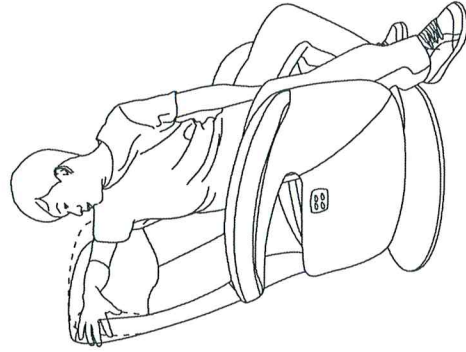

To return headrest back: push on both sides or use forearm to evenly move headrest back.

CAUTION-

Do not push in the center of the headrest as this may cause foam cushion to collapse.

